

35-55V
Input

9.6V
Output

27A
Current

2000Vdc
Isolation

Eighth-brick
DC Bus Converter

The BusQor® BQ55090ETA27 bus converter is a next-generation, board-mountable, isolated, fixed switching frequency DC/DC converter that uses synchronous rectification to achieve extremely high conversion efficiency. The power dissipated by the converter is so low that a heatsink is not required, which saves cost, weight, height, and application effort. The BusQor series provides an isolated step down voltage from 48V to a 9.6V intermediate bus with no regulation in a standard "eighth-brick" module. BusQor converters are ideal for creating the mid-bus voltage required to drive point-of-load (non-isolated) converters in intermediate bus architectures. RoHS compliant (see page 12).

BusQor®

Bus Converter



BQ55090ETA27 Module

Operational Features

- Ultra-high efficiency, >95% at full rated load current
- Delivers up to 27 amps of output current with minimal derating - no heatsink required
- Input voltage range: 35V – 55V provides 6.5-11V bus for distributed power architectures
- Fixed frequency switching provides predictable EMI performance

Mechanical Features

- Industry standard eighth-brick bus converter pin-out
- Industry standard size: 0.90" x 2.3" x .484" (22.9x58.4x11.76mm)
- Total weight: 0.7 oz. (20 grams)
- Flanged pins designed to permit surface mount soldering (avoid wave solder) using FPiP technique

Control Features

- On/Off control referenced to input side (positive and negative logic options available)

Protection Features

- Input under-voltage lockout and over-voltage shutdown protects against abnormal input voltages
- Output current limit and short circuit protection (auto recovery)
- Output over-voltage protection
- Thermal shutdown

Safety Features

- 2000V, 30 MΩ input-to-output isolation
- UL/cUL 60950-1 recognized (US & Canada), basic insulation rating
- TUV certified to EN60950-1
- Meets 72/23/EEC and 93/68/EEC directives
- Meets UL94V-0 flammability requirements

Input: 35-55 V
Output: 9.6 V
Current: 27 A
Package: Eighth-brick

MECHANICAL DIAGRAM

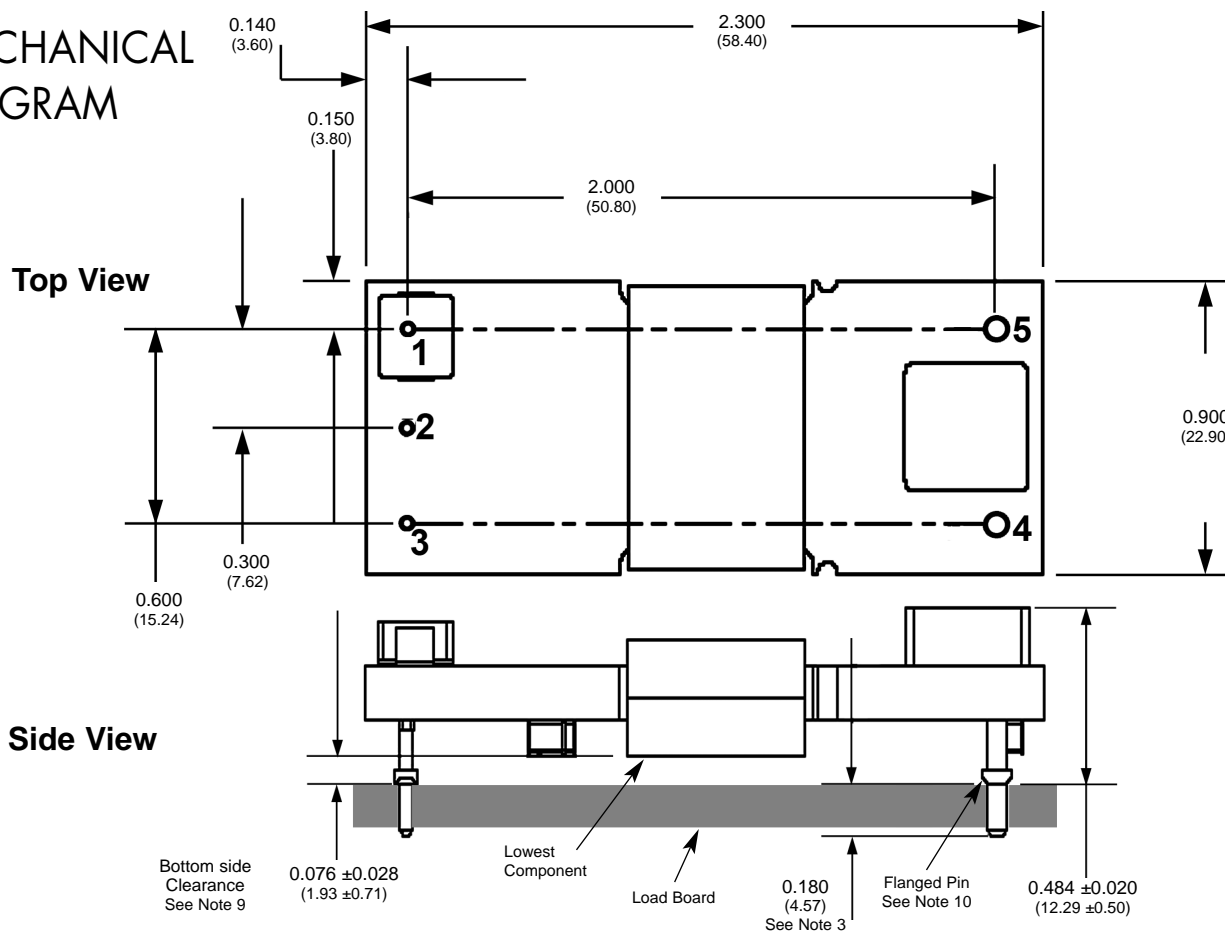

NOTES

- 1) Pins 1-3 are 0.040" (1.02mm) diameter with 0.080" (2.03 mm) diameter standoff shoulders.
- 2) Pins 4 and 5 are 0.062" (1.57 mm) diameter with 0.100" (2.54 mm) diameter standoff shoulders.
- 3) Other pin extension lengths available. Recommended pin length is 0.03" (0.76mm) greater than the PCB thickness.
- 4) All Pins: Material - Copper Alloy
 Finish (RoHS 5/6) - Tin/Lead over Nickel plate
 Finish (RoHS 6/6) - Matte Tin over Nickel plate
- 5) Unmeasured components are shown for visual reference only.
- 6) All dimensions in inches (mm)
 Tolerances: x.xx ±0.02 in. (x.x ±0.5mm)
 x.xxx ±0.010 in. (x.xx ±0.25mm)
- 7) Weight: 0.7 oz. (20 g) typical
- 8) Workmanship: Meets or exceeds IPC-A-610C Class II
- 9) UL/TUV standards require a clearance of 0.04" (1.02mm) around primary areas of the module. Refer to section on [Keep Out Areas](#) under Application Considerations for details.
- 10) The flanged pins are designed to permit surface mount soldering (allowing to avoid the wave soldering process) through the use of the flanged pin-in-paste technique.

PIN DESIGNATIONS

Pin No.	Name	Function
1	Vin(+)	Input Positive (35V - 55V)
2	ON/OFF	Logic control input to turn converter on and off.
3	Vin(-)	Input Negative
4	Vout(-)	Output Negative
5	Vout(+)	Output Positive



Technical Specification

Input: 35-55 V
Output: 9.6 V
Current: 27 A
Package: Eighth-brick

BQ55090ETA27 ELECTRICAL CHARACTERISTICS

$T_A=25^{\circ}\text{C}$, airflow rate=300 LFM, $V_{in}=48\text{Vdc}$ unless otherwise noted; full operating temperature range is -40°C to $+100^{\circ}\text{C}$ ambient temperature with appropriate power derating. Specifications subject to change without notice.

Parameter	Min.	Typ.	Max.	Units	Notes & Conditions
ABSOLUTE MAXIMUM RATINGS					
Input Voltage					
Non-Operating			60	V	Continuous
Operating			56	V	Continuous
Isolation Voltage (input to output)			2000	V	Basic insulation, Pollution Degree 2
Operating Temperature	-40		100	$^{\circ}\text{C}$	
Storage Temperature	-55		125	$^{\circ}\text{C}$	
Voltage at ON/OFF input pin	-2		18	V	
INPUT CHARACTERISTICS					
Operating Input Voltage Range	35	48	55	V	
Input Under-Voltage Lockout					
Turn-On Voltage Threshold		34.3		V	
Turn-Off Voltage Threshold		32		V	
Lockout Voltage Hysteresis		2.4		V	
Input Over-Voltage Shutdown					
Turn-Off Voltage Threshold		59.2		V	
Turn-On Voltage Threshold		56.9		V	
Maximum Input Current			5.8	A	100% Load, 35 V_{in}
No-Load Input Current			0.10	A	
Disabled Input Current		15		mA	
Inrush Current Transient Rating			0.1	A^2s	
Input Reflected Ripple Current		3.8	7.0	mA	RMS through 10 μH inductor; Figures 12 & 14
Input Terminal Ripple Current		250		mA	RMS, full load; Figures 13
Recommended Input Fuse			20	A	Fast blow external fuse recommended
Input Filter Component Values (L\C)		1.5\2.0		$\mu\text{H}\backslash\mu\text{F}$	Internal values
Recommended External Input Capacitance		47		μF	Typical ESR 0.1-0.2 Ω , see Figure 12
OUTPUT CHARACTERISTICS					
Output Voltage Set Point		9.60		V	48 V_{in} , no load
Output Voltage Regulation					
Over Line		40/3.8		%\V	Figure 4
Over Load		4.8/460		%\mV	Figure 4
Over Temperature		2/200		%\mV	Figure 4
Total Output Voltage Range	6.3		11.0	V	Over sample, line, load, temperature & life
Output Voltage Ripple and Noise ¹					20MHz bandwidth; Figure 12 & 15
Peak-to-Peak		100	120	mV	Full Load; see Figures 12 & 15
RMS		20	40	mV	Full Load; see Figures 12 & 15
Operating Output Current Range	0		27	A	Subject to thermal derating; Figures 5 & 7
Output DC Current-Limit Inception		34		A	Output Voltage 10% Low; Figure 16
Output DC Current-Limit Shutdown Voltage		0		V	
Current Share Accuracy (3 units paralleled)		± 10		%	% of rated output current
Back-Drive Current Limit while Disabled		10		mA	Negative current drawn from output
Maximum Output Capacitance			3,000	μF	9.6 V_{out} at 27A Resistive Load
DYNAMIC CHARACTERISTICS					
Output Voltage during Load Current Transient					
For a Step Change in Output Current (0.1A/ μs)		150		mV	50% to 75% to 50% lout max; Figure 11
Settling Time		200		μs	To within 1% V_{out} nom
Turn-On Transient					
Turn-On Time		1		ms	Full load, $V_{out}=90\%$ nom.; Figures 9 & 10
Start-Up Inhibit Time		20		ms	-40°C to $+125^{\circ}\text{C}$
Output Voltage Overshoot		0		%	2,500 μF load capacitance, lout = 0A
EFFICIENCY					
100% Load		95.7		%	Figures 1 & 3
50% Load		96.1		%	Figures 1 & 3
TEMPERATURE LIMITS FOR POWER DERATING CURVES					
Semiconductor Junction Temperature			125	$^{\circ}\text{C}$	Package rated to 150 $^{\circ}\text{C}$
Board Temperature			125	$^{\circ}\text{C}$	UL rated max operating temp 130 $^{\circ}\text{C}$
Transformer Temperature			125	$^{\circ}\text{C}$	See Figures 5 & 7 for derating curves
ISOLATION CHARACTERISTICS					
Isolation Voltage (dielectric strength)		2000		V	
Isolation Resistance		30		$\text{M}\Omega$	

Note 1: For applications requiring reduced output voltage ripple and noise, consult SynQor applications support (e-mail: support@synqor.com)



Technical Specification

Input: 35-55 V
Output: 9.6 V
Current: 27 A
Package: Eighth-brick

ELECTRICAL CHARACTERISTICS (Continued)

Parameter	Min.	Typ.	Max.	Units	Notes & Conditions
FEATURE CHARACTERISTICS					
Switching Frequency	120	150	180	kHz	
ON/OFF Control (Option P)					
Off-State Voltage	-1.0		0.8	V	
On-State Voltage	2.4		18	V	
ON/OFF Control (Option N)					
Off-State Voltage	2.4		18	V	
On-State Voltage	-1.0		0.8	V	
ON/OFF Control (Either Option)					Figures A & B
Pull-Up Voltage		9		V	
Pull-Up Resistance		124		kΩ	
Output Over-Voltage Protection		11.6		V	Over full temp range; no load
Over-Temperature Shutdown	140		150	°C	Average PCB Temperature
Over-Temperature Shutdown Restart Hysteresis		10		°C	
Load Current Scale Factor		1667			See App Note: Output Load Current Calc.
RELIABILITY CHARACTERISTICS					
Calculated MTBF (Telcordia)		2.36		10 ⁶ Hrs.	TR-NWT-000332; 80% load, 300LFM, 40°C T _a
Calculated MTBF (MIL-217)		1.79		10 ⁶ Hrs.	MIL-HDBK-217F; 80% load, 300LFM, 40°C T _a
Field Demonstrated MTBF				10 ⁶ Hrs.	See our website for values

STANDARDS COMPLIANCE

Parameter	Notes
STANDARDS COMPLIANCE	
UL/cUL 60950-1	File # E194341, Basic insulation & pollution degree 2
EN60950-1	Certified by TÜV
72/23/EEC	
93/68/EEC	
Needle Flame Test (IEC 695-2-2)	Test on entire assembly; board & plastic components UL94V-0 compliant
IEC 61000-4-2	ESD test, 8kV - NP, 15kV air - NP (Normal Performance)
GR-1089-CORE	Section 7 - electrical safety, Section 9 - bonding/grounding

- An external input fuse must always be used to meet these safety requirements. Contact SynQor for official safety certificates on new releases or download from the [SynQor website](#).

QUALIFICATION TESTING

Parameter	# Units	Test Conditions
QUALIFICATION TESTING		
Life Test	32	95% rated V _{in} and load, units at derating point, 1000 hours
Vibration	5	10-55Hz sweep, 0.060" total excursion, 1 min./sweep, 120 sweeps for 3 axis
Mechanical Shock	5	100g minimum, 2 drops in x and y axis, 1 drop in z axis
Temperature Cycling	10	-40°C to 100°C, unit temp. ramp 15°C/min., 500 cycles
Power/Thermal Cycling	5	Toperating = min to max, V _{in} = min to max, full load, 100 cycles
Design Marginality	5	T _{min} -10°C to T _{max} +10°C, 5°C steps, V _{in} = min to max, 0-105% load
Humidity	5	85°C, 85% RH, 1000 hours, 2 minutes on and 6 hours off
Solderability	3	MIL-STD-883, method 2003

- Extensive characterization testing of all SynQor products and manufacturing processes is performed to ensure that we supply robust, reliable product. Contact the factory for official product family qualification documents.

OPTIONS

SynQor provides various options for Logic Sense, Pin Length and Feature Set for this family of DC/DC converters. Please consult the [last page](#) for information on available options.

PATENTS

SynQor is protected under various patents, including but not limited to U.S. Patent numbers 5,999,417; 6,222,742 B1; 6,594,159 B2; 6,545,890 B2.

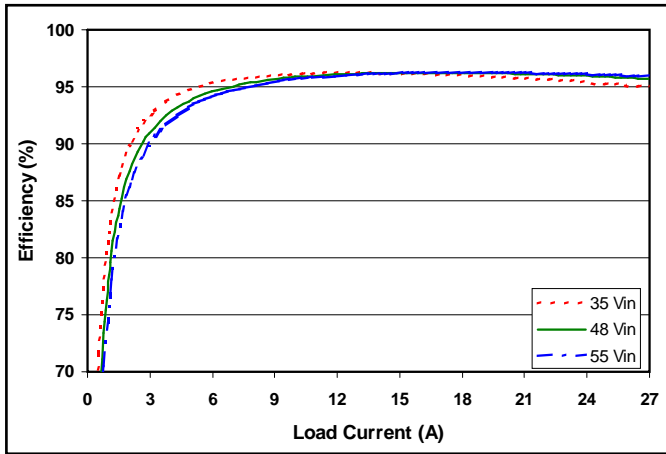

Figure 1: Efficiency at nominal output voltage vs. load current for minimum, nominal, and maximum input voltage at 25°C.

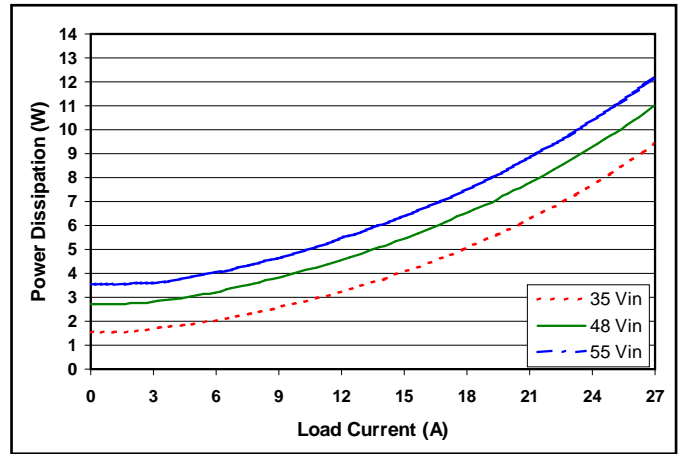

Figure 2: Power dissipation at nominal output voltage vs. load current for minimum, nominal, and maximum input voltage at 25°C.

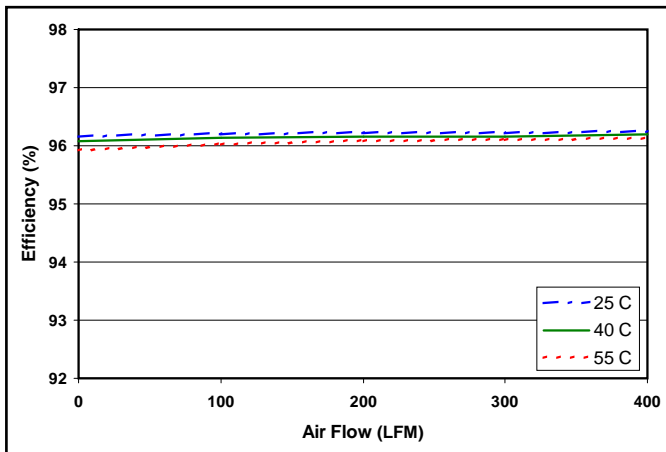

Figure 3: Efficiency at nominal output voltage and 60% rated power vs. airflow rate for ambient air temperatures of 25°C, 40°C, and 55°C (nominal input voltage).

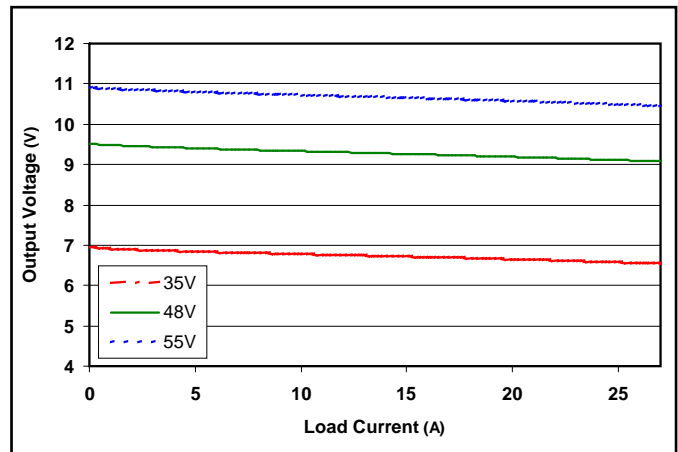

Figure 4: Output voltage regulation vs. load current for minimum, nominal, and maximum input voltage at 25°C.

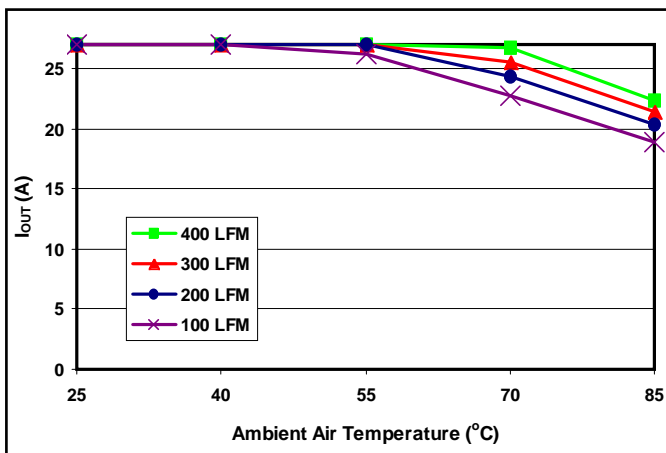

Figure 5: Maximum output power derating curves vs. ambient air temperature for airflow rates of 100 LFM through 400 LFM with air flowing from pin 1 to pin 3 (nominal input voltage).

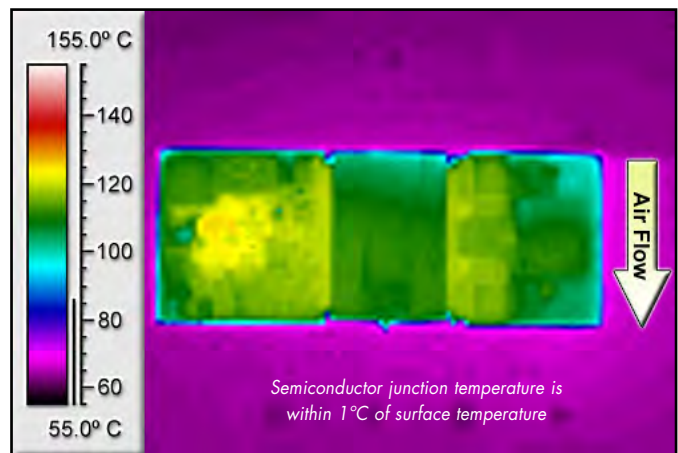

Figure 6: Thermal plot of converter at 27 amp load current (250W) with 55°C air flowing at the rate of 200 LFM. Air is flowing across the converter from pin 1 to pin 3 (nominal input voltage).

Input: 35-55 V
Output: 9.6 V
Current: 27 A
Package: Eighth-brick

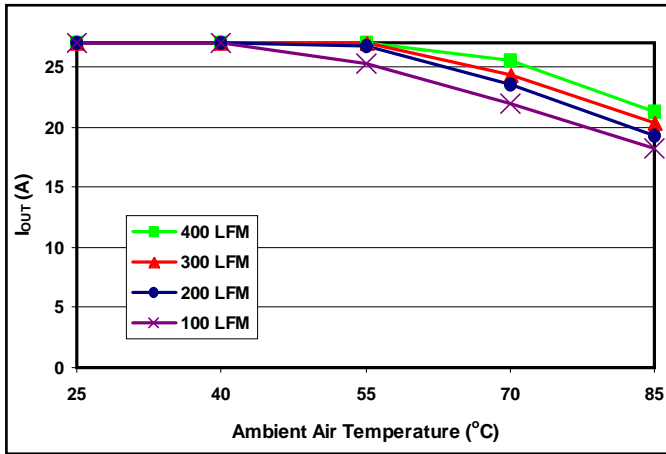

Figure 7: Maximum output power derating curves vs. ambient air temperature for airflow rates of 100 LFM through 400 LFM with air flowing from output to input (nominal input voltage).

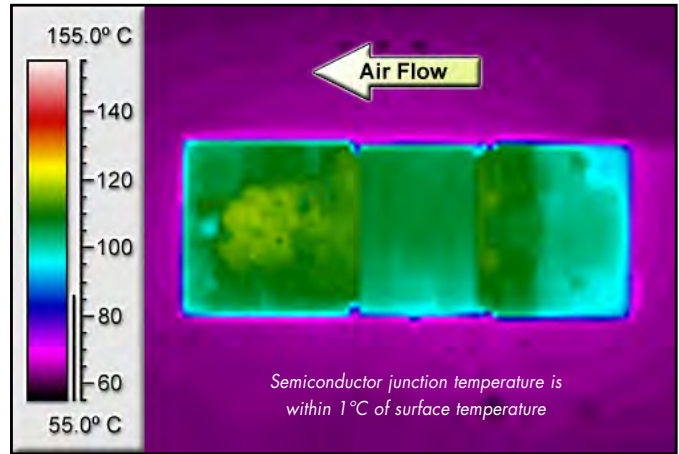

Figure 8: Thermal plot of converter at 27 amp load current (250W) with 55°C air flowing at the rate of 200 LFM. Air is flowing across the converter from output to input (nominal input voltage).

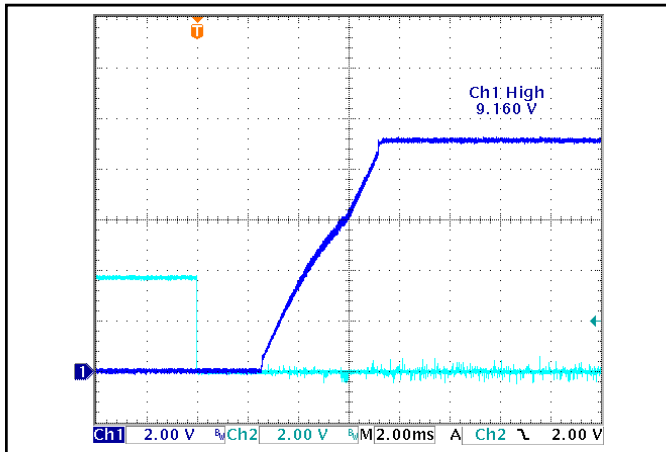

Figure 9: Turn-on transient at full load (resistive load) (1.0 ms/div). Input voltage pre-applied. Top Trace: V_{OUT} (2V/div). Bottom Trace: ON/OFF input (1V/div).

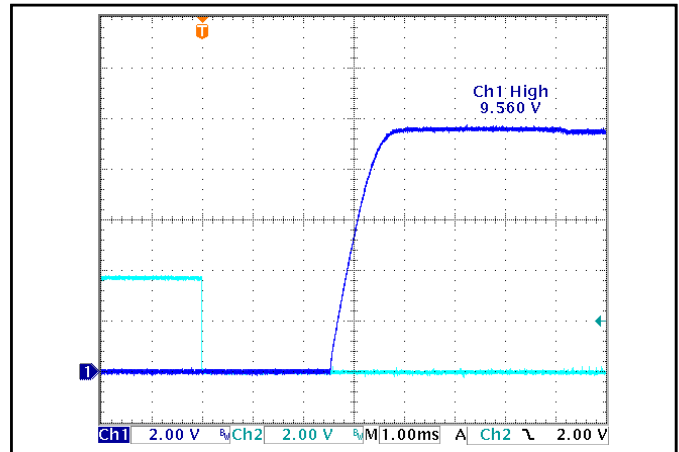

Figure 10: Turn-on transient at zero load (1.0 ms/div). Top Trace: V_{OUT} (2V/div). Bottom Trace: ON/OFF input (1V/div).

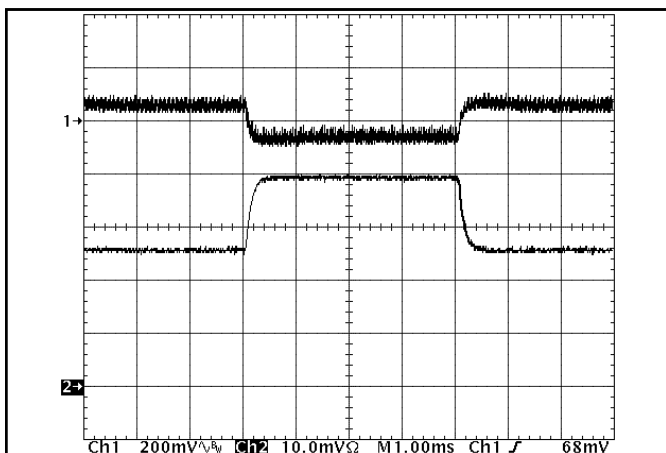

Figure 11: Output voltage response to step-change in load current (50%-75%-50% of I_{OUT}(max); dI/dt = 0.1A/μs). Load cap: 15μF, 100 mΩ ESR tantalum cap and 1μF ceramic cap. Top trace: V_{OUT} (200mV/div), Bottom trace: I_{OUT} (5A/div).

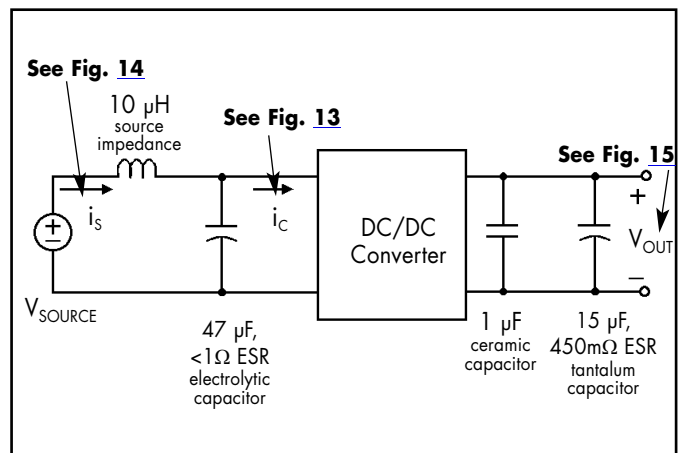

Figure 12: Test set-up diagram showing measurement points for Input Terminal Ripple Current (Figure 13), Input Reflected Ripple Current (Figure 14) and Output Voltage Ripple (Figure 15).

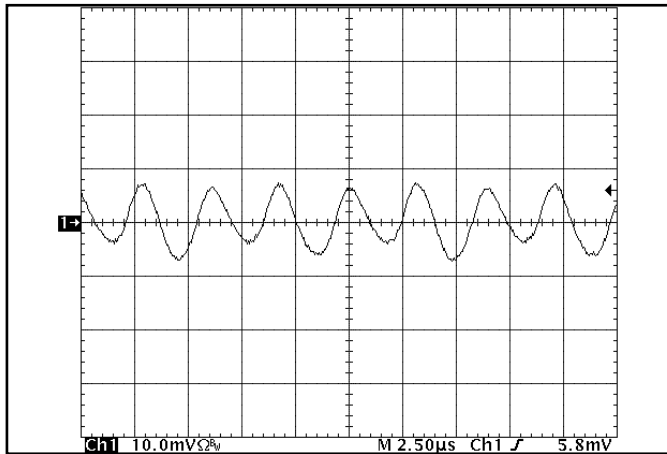

Figure 13: Input Terminal Ripple Current, i_c , at full rated output current and nominal input voltage with $10\mu\text{H}$ source impedance and $47\mu\text{F}$ electrolytic capacitor (500 mA/div). See Figure 12.

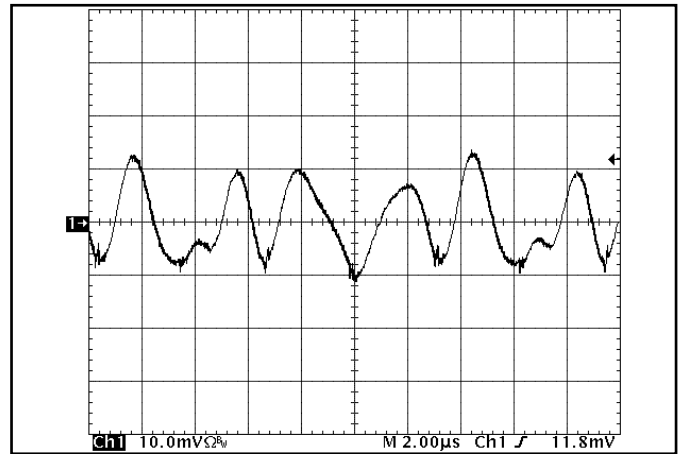

Figure 14: Input reflected ripple current, i_s , through a $10\mu\text{H}$ source inductor at nominal input voltage and rated load current (20mA/div). See Figure 12.

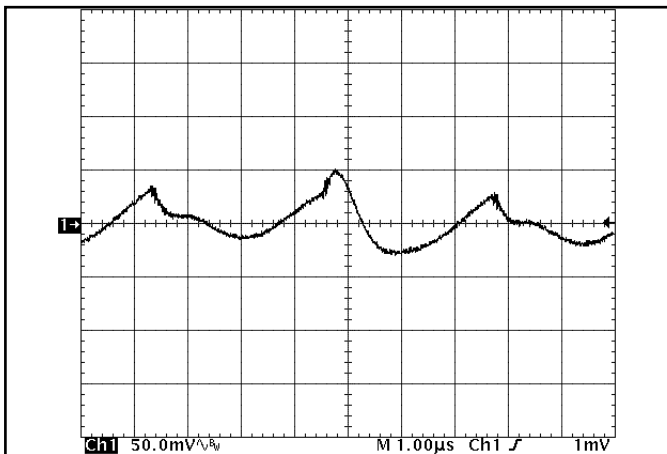

Figure 15: Output voltage ripple at nominal input voltage and rated load current (50 mV/div). Load capacitance: $1\mu\text{F}$ ceramic capacitor and $15\mu\text{F}$ tantalum capacitor. Bandwidth: 20 MHz. See Figure 12.

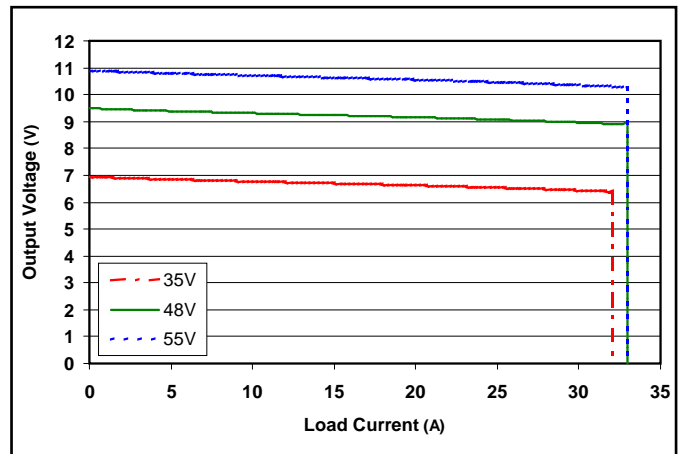

Figure 16: Output voltage vs. load current showing typical current limit curves and converter shutdown points.

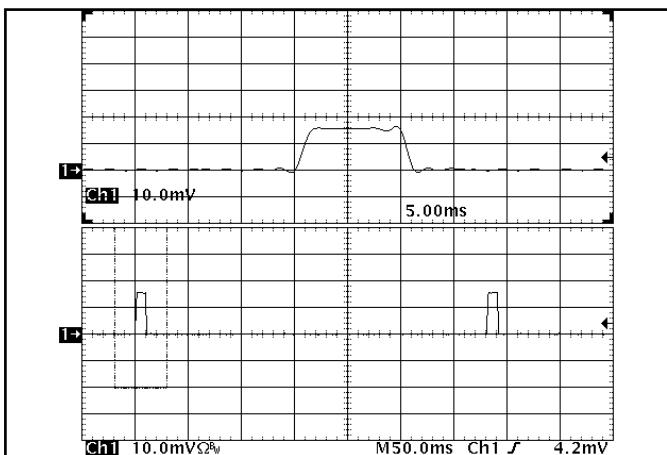

Figure 17: Load current (50A/div) as a function of time when the converter attempts to turn on into a $1\text{m}\Omega$ short circuit. Top trace (5.0ms/div) is an expansion of the on-time portion of the bottom trace.

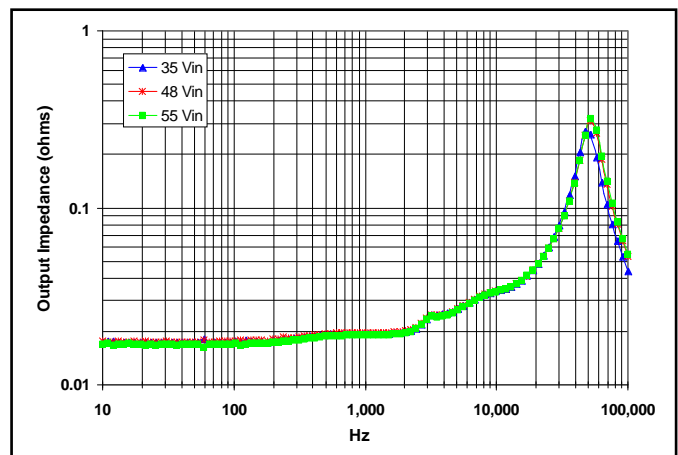

Figure 18: Magnitude of incremental output impedance ($Z_{out} = v_{out}/i_{out}$) for minimum, nominal, and maximum input voltage at full rated power.

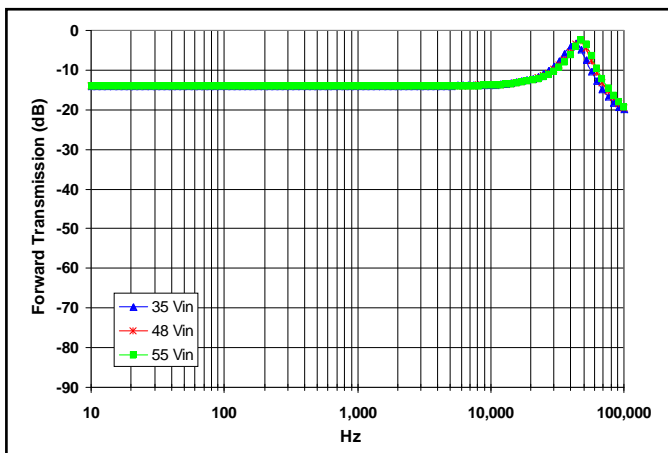

Figure 19: Magnitude of incremental forward transmission ($FT = v_{out}/v_{in}$) for minimum, nominal, and maximum input voltage at full rated power.

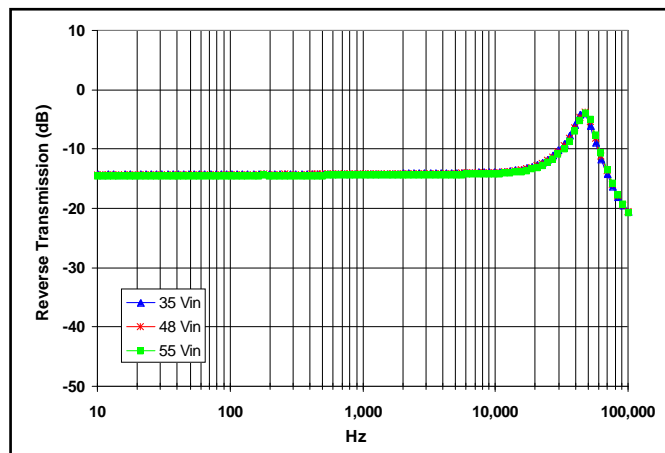

Figure 20: Magnitude of incremental reverse transmission ($RT = i_{in}/i_{out}$) for minimum, nominal, and maximum input voltage at full rated power.

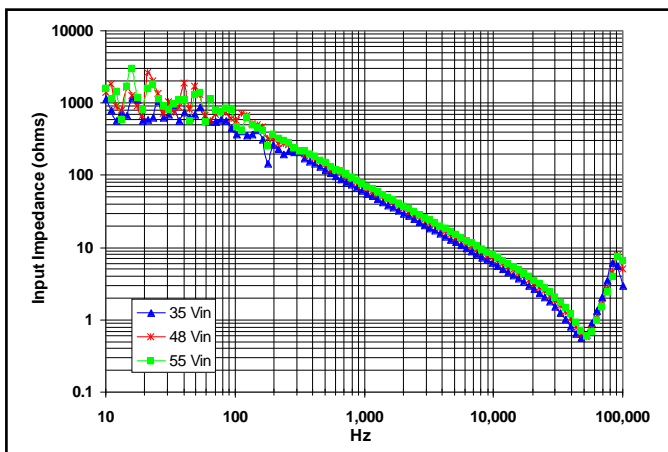

Figure 21: Magnitude of incremental input impedance ($Z_{in} = v_{in}/i_{in}$) for minimum, nominal, and maximum input voltage at full rated power.

BASIC OPERATION AND FEATURES

With voltages dropping and currents rising, the economics of an Intermediate Bus Architecture (IBA) are becoming more attractive, especially in systems requiring multiple low voltages. IBA systems separate the role of isolation and voltage scaling from regulation and sensing. The BusQor series bus converter provides isolation and a coarse voltage step down in one compact module, leaving regulation to simpler, less expensive non-isolated converters.

In Figure A below, the BusQor module provides the isolation stage of the IBA system. The isolated bus then distributes power to the non-isolated buck regulators to generate the required voltage levels at the point of load. In many applications requiring multiple low voltage outputs, significant savings can be achieved in board space and overall system costs.

When designing an IBA system with bus converters, the designer can select from a variety of bus voltages. While there is no universally ideal bus voltage, most designs employ one of the following: 12V, 9V, 7.5V, 5V, or 3.3V. Higher bus voltages can lead to lower efficiency for the buck regulators but are more efficient for the bus converter and provide lower board level distribution current. Lower bus voltages offer the opposite trade offs.

SynQor's 9.6Vout BusQor module acts as a true dc transformer. The output voltage is proportional to the input voltage, with a specified "turns ratio" or voltage ratio, plus minor drop from the internal resistive losses in the module. When used in IBA systems, the output variation of the BusQor must be in accordance with the input voltage range of the non-isolated converters being employed.

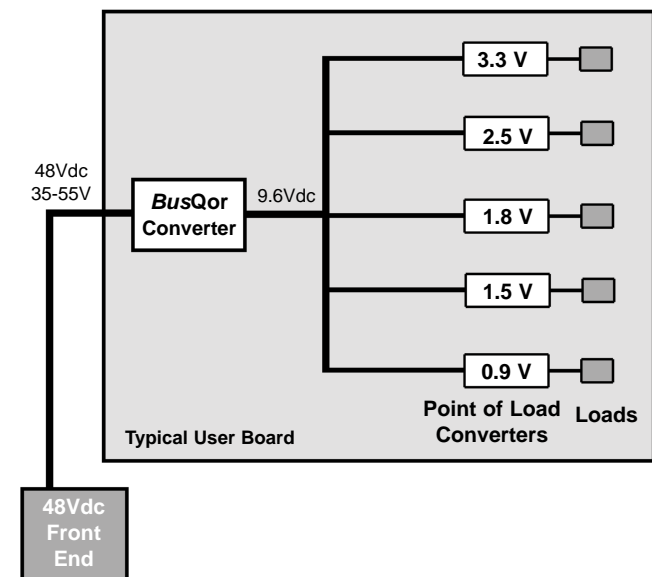

Figure A: Example of Intermediate Bus Architecture using BusQor bus converter and point of load non-isolated converters

The BusQor architecture is very scalable, meaning multiple bus converters can be connected directly in parallel to allow current sharing for higher power applications.

CONTROL FEATURES

REMOTE ON/OFF (Pin 2): The ON/OFF input, Pin 2, permits the user to control when the converter is on or off. This input is referenced to the return terminal of the input bus, Vin(-). There are two versions of the converter that differ by the sense of the logic used for the ON/OFF input.

In the positive logic version, the ON/OFF input is active high (meaning that a high turns the converter on). In the negative logic version, the ON/OFF signal is active low (meaning that a low turns the converter on). Figure B is a detailed look of the internal ON/OFF circuitry.

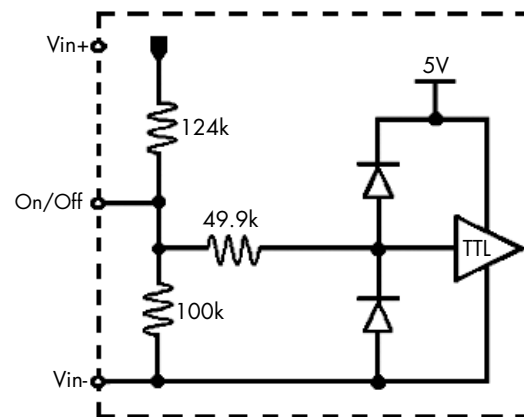

Figure B: Internal ON/OFF pin circuitry

PROTECTION FEATURES

Input Under-Voltage Lockout: The converter is designed to turn off when the input voltage is too low, helping avoid an input system instability problem, described in more detail in the application note titled "Input System Instability". The lockout circuitry is a comparator with DC hysteresis. When the input voltage is rising, it must exceed the typical Turn-On Voltage Threshold value (listed on the specification page) before the converter will turn on. Once the converter is on, the input voltage must fall below the typical Turn-Off Voltage Threshold value before the converter will turn off. Also see Figure E.

Output Current Limit: The output of the *BusQor* module is electronically protected against output overloads. When an overload current greater than the “DC Current-Limit Inception” specification is drawn from the output, the output shuts down to zero volt in a period of 10mS typical (see Figure C). The shutdown period lasts for a typical period of 250mS (Figure D) after which the *BusQor* tries to power up again. If the overload persists, the output voltage will go through repeated cycles of shutdown and restart with a duty cycle of 3% (On) and 97% (Off) respectively. The *BusQor* module returns (auto resetting) to normal operation once the overload is removed. The *BusQor* is designed to survive in this mode indefinitely without damage and without human intervention.

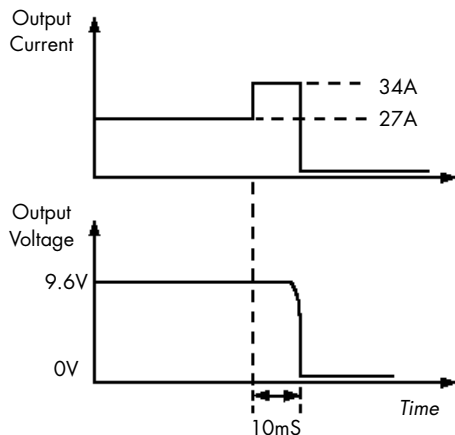

Figure C: Output Overload protection diagram (not to scale)

Output Short Circuit Protection: When the output of the *BusQor* module is shorted, a peak current of typically 34A will flow into the short circuit for a period of about 10mS. The output of the *BusQor* will shutdown to zero volts for the same period (Figure E). The shutdown period lasts for a period of 250mS, at the end of which the *BusQor* module tries to power up again. If the short circuit persists, the output voltage will go through repeat-

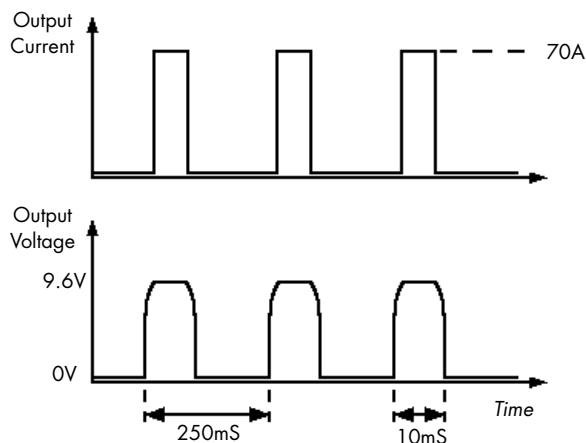

Figure D: Output Short Circuit and Auto-Resetting protection diagram (not to scale)

ed cycles of shutdown and restart with a duty cycle of 3% (On) and 97% (Off) respectively. The *BusQor* module returns (auto resetting) to normal operation once the short circuit is removed. The *BusQor* is designed to survive in this mode indefinitely without damage and without human intervention.

In the Auto resetting mode, also referred to as “Hiccup” mode, the power drawn from the 48V input is about 5 Watts, most of which is dissipated into the external fault. It is important that copper traces and pads from the output circuit be designed to withstand the short term peaks, although the average current into the fault may be as low as 2A typical. See Figure 17 for appropriate waveform.

Over-Temperature Shutdown: A temperature sensor on the converter senses the average temperature of the module. The thermal shutdown circuit is designed to turn the converter off when the temperature at the sensed location reaches the Over-Temperature Shutdown value. It will allow the converter to turn on again when the temperature of the sensed location falls by the amount of the Over-Temperature Shutdown Restart Hysteresis value.

APPLICATION CONSIDERATIONS

Start-Up Inhibit Period: Figure E details the Start-Up Inhibit Period for the *BusQor* module. At time t_0 , when V_{in} is applied with On/Off pin asserted (enabled), the *BusQor* output begins to build up. Before time t_1 , when the input voltage is below the UVL threshold, the unit is disabled by the Input Under-Voltage Lockout feature. When the input voltage rises above the UVL threshold, the Input Under-Voltage Lockout is released, and a typical Startup Inhibit Period of 3mS is initiated. The output builds up to 90% or higher of the nominal voltage and stabilizes at the nominal value of 9.6V. The rise time from 0V to 90% is 4.5mS typical.

At time t_2 , when the On/Off pin is de-asserted (disabled), the *BusQor* output instantly drops to 0V. Fall time from 9.6V to 0V is dependent on output capacitance and any parasitic trace inductance in the output load circuit.

At time t_3 , when the On/Off pin is re-asserted (enabled), the *BusQor* module output begins to build up after the inhibit period of 2.5mS typical.

Refer to the Control Features section of the data sheet for details on enabling and disabling methods for N and P logic type modules.

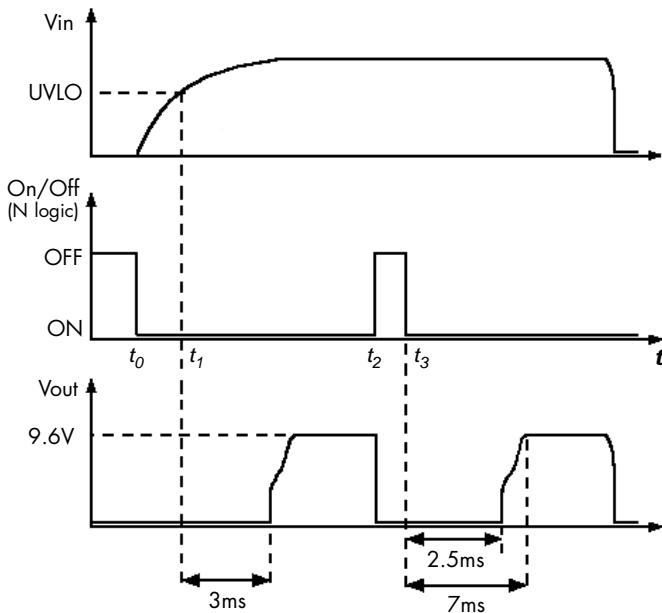

Figure E: Power Up/Down Diagram (not to scale) showing Start-Up Inhibit Period.

Keep Out Areas:

Component Keep Out Area: Keep out areas for components not referenced to the Primary circuit are shown in shaded areas in Figure F. The keep out areas shown are consistent with UL's requirements for Basic Insulation of 0.04" (40 mils) for Pollution degree 2. User should consult UL standards for other insulation classes and operating environments.

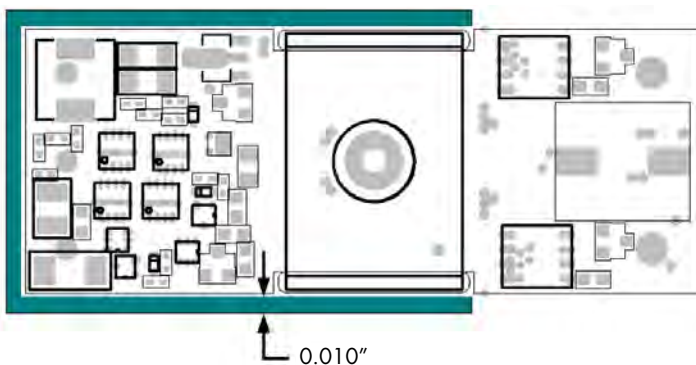

Figure F: Keep Out Areas for BusQor module

For applications that require mounting parts BELOW the BusQor module, one should be aware of potential high levels of electromagnetic interference, in addition to safety keep out. Users are advised to consult SynQor Applications engineering in such applications.

Copper Keep Out Area: Keep out areas shown in Figure F are to be observed for Top layer copper traces and vias. Internal layers buried one or more layers may be exempt, depending on the PCB material grade and thickness. Users are advised to consult UL standards for details.

All layers including top and bottom, are subject to the keep out areas shown around Primary pins of BusQor module. Actual keep outs along the surface (Creepage) may vary depending on the PCB material CTI. Users are advised to consult UL standards for details.

Bridging Components: Bridging components like EMI filter capacitors required to be placed as close as possible to the BusQor module for optimum performance must observe the clearance/creepage requirements of 0.04" (40 mils) between pads to maintain compliance to UL standards for the overall power system.

Note: Referenced keep out widths are adequate to withstand UL's Basic Insulation Dielectric strength tests for approved PCB materials. Applications requiring Double or Reinforced insulation must double the keep out widths shown in Figure F. Keep out areas shown have standard margins above UL's minimum requirements.

Output Load Current Calculation: The BusQor series allows the converter output load to be measured without adding a current loop or external shunt resistor to the designer's PCB board under test. On the top side of the BusQor converter is a current sense resistor as shown in Figure G. The output load current is proportional to the voltage drop across this sense resistor. This calculation is detailed below.

A current sense resistor referenced to the primary input is used in the equation below to calculate the output load current.

$$I_{load} = (V_{Rsense(full\ load)} - V_{Rsense(no\ load)}) * 1667$$

where:

I_{load} = output load current

$V_{Rsense(load)}$ = voltage across the sense resistor with converter under load

$V_{Rsense(no\ load)}$ = voltage across the sense resistor with converter at zero load

The number 1667 is a "Load Current Scale Factor" for this product, valid only for $V_{in} = 48V$. Hence, measurement should be made at this input voltage.

The voltage drop across the sense resistor is about 16.2mV at full load of 27A. Therefore, proper measuring techniques must

be used to ensure accuracy. A calibrated DMM set to 300mV is acceptable. Since this measurement is done on the Primary area of the converter, a slight non-linearity may be observed over the load current range. Using the Scale Factor referenced above, the error may be on the order of 4%. For more detailed information consult the application note on SynQor's website titled "Output Load Current Calculations".



Figure G: Location of Sense Resistors

Input capacitor: We recommend a suitable aluminum electrolytic capacitor across the input terminals of the converter, to decouple source inductance and provide damping for the input circuit to avoid input instability. The capacitor must have a ripple current rating consistent with the "input terminal ripple current" specification of the converter in order to avoid premature failure of the capacitor. The examples below are of the recommended type and have ripple current ratings above the converter's input terminal ripple current rating, to provide design margin and extend the lifetime of the capacitor.

Vendor	Part Number	Description
Panasonic	EEUFC2A560	56uF, 100V, 460mA rms ripple current rating at 105C, 10x20mm (dia x height) package
Nichicon	UPJ2A470MHD	47uF, 100V, 402mA rms ripple current rating at 105C, 12x15mm package (lower height)
Panasonic	EEUFC1J470	47uF, 63V, 405 mA rms, 8x12 mm package

Current Sharing: BusQor modules are designed to operate in parallel without the use of any external current share circuitry. A typical circuit for paralleling two BusQor modules is shown in Figure H. An output capacitor is recommended across each module and located close to the converter for optimum filtering and noise control performance. Dedicated input inductors are recommended but are considered optional. Input capacitors must be located close to the converter module. PCB layout in the input circuit should be such that high frequency ripple currents of each module is restricted to a loop formed by the input capacitors and the input terminals of the BusQor module. See Figure J for details on PCB layout. Contact SynQor application engineering for further assistance on PCB trace design.

The current share performance of two paralleled modules is illustrated in the graph in Figure K. In this graph the percent deviation

from ideal sharing (50%) is plotted for each module versus the total output load current at 48Vin.

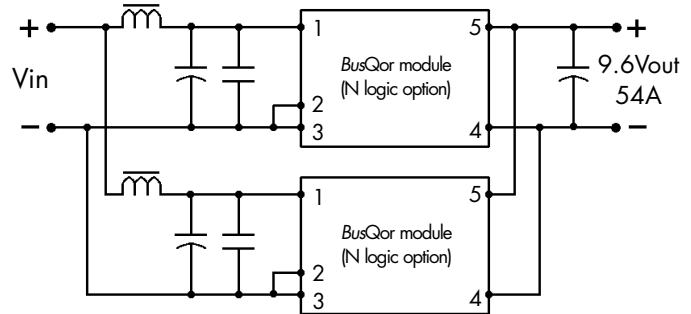

Figure H: BusQor Output Paralleling for increased current output.

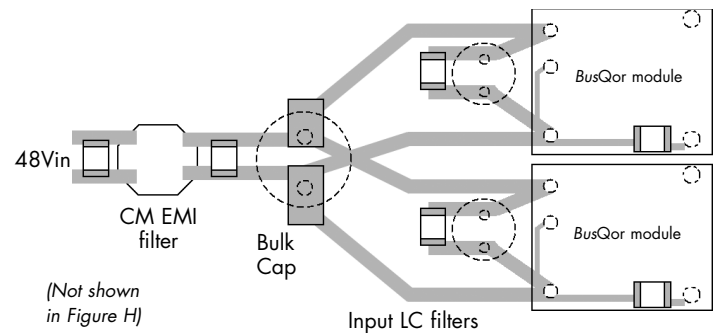

Figure J: Recommended PCB layout for input circuit

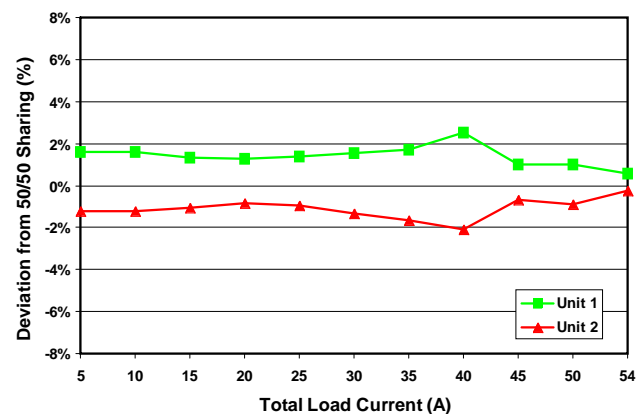

Figure K: Current share performance of 2 paralleled modules

RoHS Compliance: The EU led RoHS (Restriction of Hazardous Substances) Directive bans the use of Lead, Cadmium, Hexavalent Chromium, Mercury, Polybrominated Biphenyls (PBB), and Polybrominated Diphenyl Ether (PBDE) in Electrical and Electronic Equipment. This SynQor product is available as 5/6 RoHS compliant (product with lead) or 6/6 RoHS compliant. For more information please refer to SynQor's RoHS addendum available at our [RoHS Compliance / Lead Free Initiative](#) web page or e-mail us at rohs@synqor.com.



Technical Specification

Input: 35-55 V
Output: 9.6 V
Current: 27 A
Package: Eighth-brick

PART NUMBERING SYSTEM

The part numbering system for SynQor's BusQor DC bus converters follows the format shown in the example below.

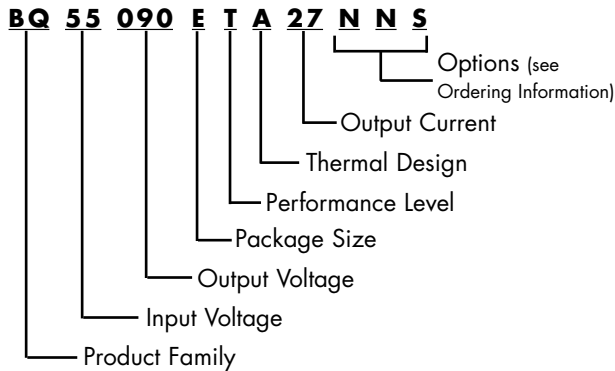

The first 12 characters comprise the base part number and the last 3 characters indicate available options. Although there are no default values for enable logic and pin length, the most common options are negative logic and 0.145" pins. These part numbers are more likely to be readily available in stock for evaluation and prototype quantities. A "-G" suffix indicates 6/6 RoHS compliance.

Application Notes

A variety of application notes and technical white papers can be downloaded in pdf format from our [website](#).

Contact SynQor for further information:

Phone: 978-849-0600
Toll Free: 888-567-9596
Fax: 978-849-0602
E-mail: power@synqor.com
Web: www.synqor.com
Address: 155 Swanson Road
 Boxborough, MA 01719
 USA

ORDERING INFORMATION

The tables below show the valid model numbers and ordering options for converters in this product family. When ordering SynQor converters, please ensure that you use the complete 15 character part number consisting of the 12 character base part number and the additional 3 characters for options. To order 6/6 RoHS compliant product please add a "-G" suffix.

Model Number	Input Voltage	Output Voltage	Max Output Current
BQ55090ETA27 xyz	35 - 55 V	9.6 V	27 A

The following option choices must be included in place of the x y z spaces in the model numbers listed above.

Options Description: x y z		
Enable Logic	Pin Length	Feature Set
P - Positive N - Negative *	K - 0.110" N - 0.145" R - 0.180" Y - 0.250"	S - Standard

* Consult the factory before ordering the P logic option

Warranty

SynQor offers a three (3) year limited warranty. Complete warranty information is listed on our [website](#) or is available upon request from SynQor.

Information furnished by SynQor is believed to be accurate and reliable. However, no responsibility is assumed by SynQor for its use, nor for any infringements of patents or other rights of third parties which may result from its use. No license is granted by implication or otherwise under any patent or patent rights of SynQor.